

# OPERATING INSTRUCTIONS AND OWNER'S MANUAL



## PORTABLE BUDDY RADIANT HEATER

Model #

MH9BX

**READ INSTRUCTIONS CAREFULLY:** Read and follow all instructions. Place instructions in a safe place for future reference. Do not allow anyone who has not read these instructions to assemble, light, adjust or operate the heater.



## User Manual and Product Specifications

### COMPACT PROPANE HEATER

Part No. MH9BX



#### IMPORTANT

Read these instructions for use carefully. Familiarise yourself with the appliance before connecting it to its gas container. Keep these instructions for future reference.

- DO NOT:** Operate this appliance before reading the instruction booklet
- DO NOT:** Place articles on or against this appliance
- DO NOT:** Store chemicals, flammable materials or spray aerosols near this appliance
- DO NOT:** Operate with panels, covers or guards removed from this appliance.
- DO NOT:** Operate in an enclosed area without ventilation
- DO NOT:** Operate in a boat, caravan or tent

Image for representation purposes only and may differ from actual product.

# Safety Instructions

## Important

---

1. Please read all instructions carefully.
2. Dispose of all polythene packaging carefully and keep out of the hands of young children.

## Safety warning

---

Please read all safety warning and assembly instructions before use. Retain all information for future reference. Failure to follow the instructions may cause personal injury and/or damage.

1. Never use in unventilated or enclosed areas. This heater consumes air and could endanger life if used in unventilated or enclosed areas.
2. Only non refillable 468g disposable cartridges are to be used with this appliance.

**CAUTION - IT MAYBE HAZARDOUS TO ATTEMPT TO FIT OTHER TYPES OF GAS CONTAINERS.**

3. Never leave heater unattended when in use.

**CAUTION** - accessible parts may be very hot. Keep young children away.

4. Always use oven mitts/oven gloves when handling the heater after use.

## Installation, operation and maintenance instructions

---

### Safety information: if you smell gas

- If there is a leak on your appliance (smell of gas), immediately attempt to turn off.
- Remove the appliance to a well ventilated location away from any ignition source.
- Only check for leaks outdoors using soapy water.
- Do not try to detect leaks using a flame.
- When leak has stopped, ventilate and disperse gas from the area before continuing.

**IMPORTANT:** read this instruction for use carefully. Familiarise yourself with the appliance before connecting it to the gas bottle. This appliance is for use with disposable propane cartridges only.

- Do not remove regulator, connect to high-pressure canister or use adaptors.
- When changing gas cartridge ensure that it is undertaken in a well ventilated area, preferably outside and away from sources of ignition such as naked flames, pilot flames, electrical and heating equipment and people.
- To check if cartridge has sufficient gas pick up cartridge and shake from side to side. If there is movement or the sounds of liquid moving inside the cartridge then it will contain gas.

### **FOR OUTDOORS USE ONLY - ONLY USE IN WELL VENTILATED AREAS.**

This appliance shall only be used in an above ground open air situation with natural ventilation, without stagnant areas, where gas leakage and products of combustion are rapidly dispersed by wind and natural convection.

**CARBON MONOXIDE HAZARD-USING THIS APPLIANCE IN AN ENCLOSED SPACE MAY CAUSE DEATH. DO NOT USE IN CARAVANS, TENTS, MARINE CRAFT, CARS, MOBILE HOMES OR SIMILAR LOCATIONS.**

## Safety after installation

The purpose of this section is to direct your attention to the possibility of accidents that can be avoided.

- This appliance is not to be used in enclosed areas and must be operated away from any type of flammable material or liquid.
- This appliance must be operated a minimum of 100mm from all solid or non-combustible surfaces.
- During the operation of this appliance all air openings and vents must be kept free from obstructions to ensure correct operation.
- Remember the appliance produces heat, therefore some parts will get hot. Allow to cool before touching.
- Do not leave children unattended near the appliance when in use.
- Do not store or use petrol or other flammable liquids in the vicinity of this or any other appliance.
- Do not modify this appliance.
- Do not use adaptors.
- Do not allow clothing to pass over or lay on the appliance.
- Protect the appliance from wind and drafts when in use.
- Do not operate appliance below ground level or in areas where unburned gas could build up.
- Do not move appliance while operating
- Clean after use.
- Do not use this appliance if it is leaking, damaged or does not work properly.
- Do not use this appliance if it has damaged or worn seals.
- This appliance must only be serviced by an authorised person.
- Store the gas cartridges safely in well ventilated areas out of reach from children and in compliance with AS1596.

## Caution

**NEVER** assemble or operate the unit on unstable or uneven ground. Always operate in open and well-ventilated areas.

**NEVER** operate inside a tent, caravan, camper trailer vehicle or boat.

**NEVER** leave the unit unattended whilst operating.

**NEVER** open the control panel or dis-assemble unit.

This appliance is not intended for use by young children or infirm person unless they have been adequately supervised by a responsible person to ensure that they can use the appliance safely. Young children should be supervised to ensure that they do not play with the appliance. This appliance is to be installed as per local regulation and in accordance with AS5601/AG601.

## Product Identification

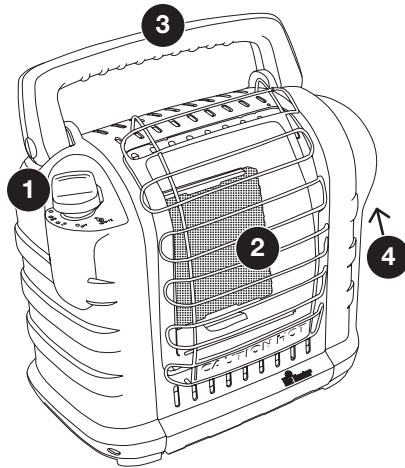

1. Control knob
2. Burner tile
3. Folding carry handle
4. Propane cartridge cavity

# Safety Instructions

This appliance shall only be used in an above ground open air situation with natural ventilation, without stagnant areas, where gas leakage and products of combustion are rapidly dispersed by wind and natural convection. Any enclosure in which the appliance is used shall comply with one of the following:

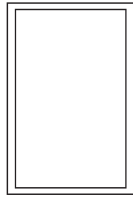
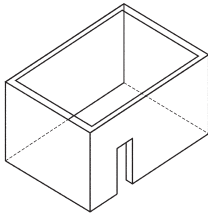

(A) An enclosure with walls on all sides, but with no overhead cover.

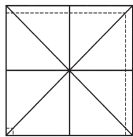
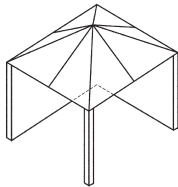

(B) Within a partial enclosure that includes an overhead cover and no more than two walls.

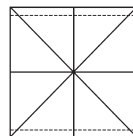
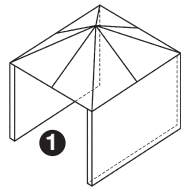

(C) Within a partial enclosure that includes an overhead cover and more than two walls, the following shall apply:

(1) At least 25% of the total wall area is completely open.

(2) 30% or more in total of the remaining wall side, back and front wall areas is open and unrestricted.

(3) In the case of balconies, 20% or more of the total wall area shall remain open and unrestricted”

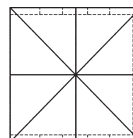
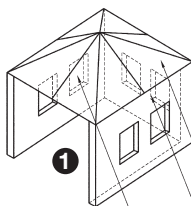
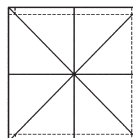
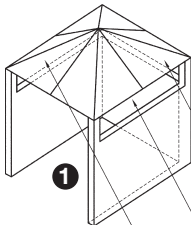

# Lighting and Operating Instructions

## Step 1

**WARNING:** Always inspect propane cartridge and heater propane connections for damage, dirt, and debris before attaching propane cartridge. Do not use if head of cartridge is damaged, punctured or deteriorated.

- Use only LP Gas cartridge marked in accordance with the U.S. Dept. of Transportation (DOT).
- Use only 468g disposable cartridges that mate with No. 600 valve connection.
- Heater and attached cartridge must be in an upright position during operation.
- Make sure four-position Control Knob is in "OFF" position.

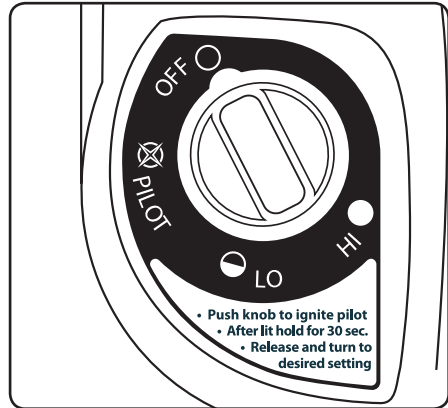

## Step 2

- Swivel regulator outward for easy tank installation. Screw 468g disposable LP Gas supply cartridge clockwise (from bottom) into portable heater until hand-tight.
- Check cartridge connection for leaks with soapy water at the threaded connection under the domed plastic cover where the cartridge screws into the regulator. SEE WARNING! ON THE UNDERSIDE OF THE DOMED PLASTIC COVER.

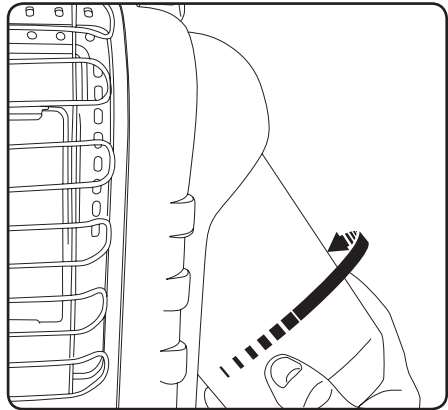

## Step 3

- Slightly depress and turn Control Knob counterclockwise to "PILOT" position and depress to light.
- If heater does not light, hold down for approximately 30 seconds; release and depress again. Repeat until pilot lights.

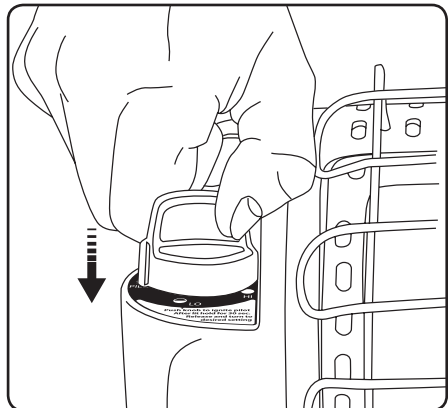

## Step 4

- After pilot lights, hold down for 30-60 seconds and then release knob. Knob should return to fully extended position.
- To operate heater, slightly depress Control Knob and gently turn to lock in the “HI” position to light burner tile. Leave on “HI” position until burner tile turns bright orange.
- After burner tile has turned bright orange, adjust heat output by turning Control Knob to desired position (“LO” or “HI” setting).

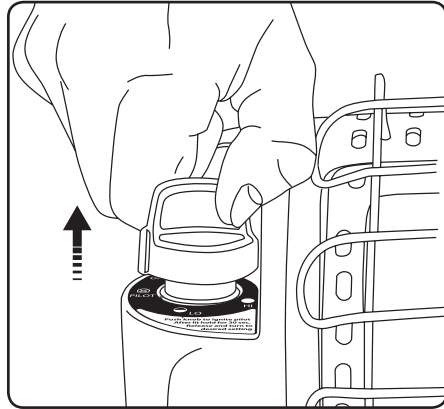

## **⚠ Warning:**

**DO NOT OPERATE HEATER UNLESS CONTROL KNOB IS LOCKED IN A POSITION MARKED “HI”, “LO” or “PILOT”.**

**NEVER SET CONTROL KNOB BETWEEN LOCKED POSITIONS. POOR COMBUSTION AND HIGHER LEVELS OF CARBON MONOXIDE MAY RESULT.**

## Shut Down Instructions

- To shut off heater, slightly push down and turn Control Knob clockwise to “OFF” position.
- **CAUTION:** After turning heater off, wire guard will remain hot. Allow to thoroughly cool before storing.
- Do not operate, store or remove cartridge near flammable items or ignition sources.
- LP-GAS CARTRIDGES MUST BE DISCONNECTED FROM HEATER WHEN NOT IN USE!

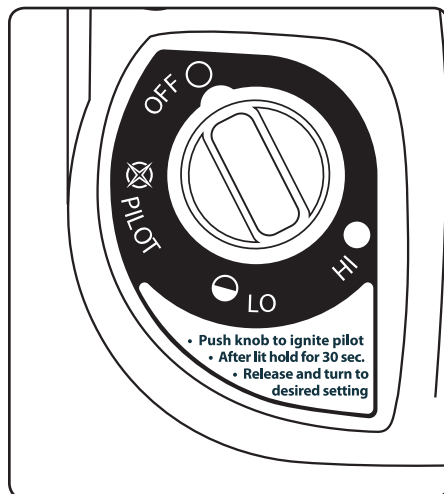

## Maintenance

**Appliance is only to be serviced or repaired by an authorised service centre. Return appliance to place of purchase or contact Sitro Customer Service (contact details on back cover).**

Always keep the heater area clear and free from combustible materials, gasoline and other flammable vapors and liquids.

Keep the vent areas (slots in the bottom and the top at the front and rear of heater) clear at all times.

Visually inspect the pilot flame and burner periodically during use. The pilot flame should be blue in color (not yellow) and will extend beyond the thermocouple.

The flame will surround the thermocouple just below the tip.

A slight yellow flame may occur where the pilot flame and main burner flame meet. The burner should be bright orange (with a slight blue color around the border, a red-orange haze that is visible on the ceramic tile is acceptable) and without a noticeable flame. A blue flame that rolls out at the top of the ceramic tile indicates an accumulation of dust, lint or spider webs inside the casing assembly and main burner assembly. If the pilot is yellow or the burner has a noticeable flame, cleaning may be required. Use the following procedure to inspect the casing assembly and main burner assembly.

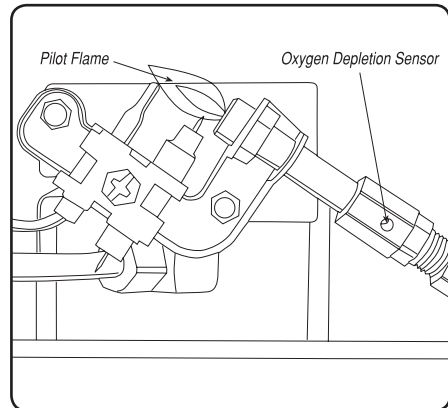

# Replacement Parts List

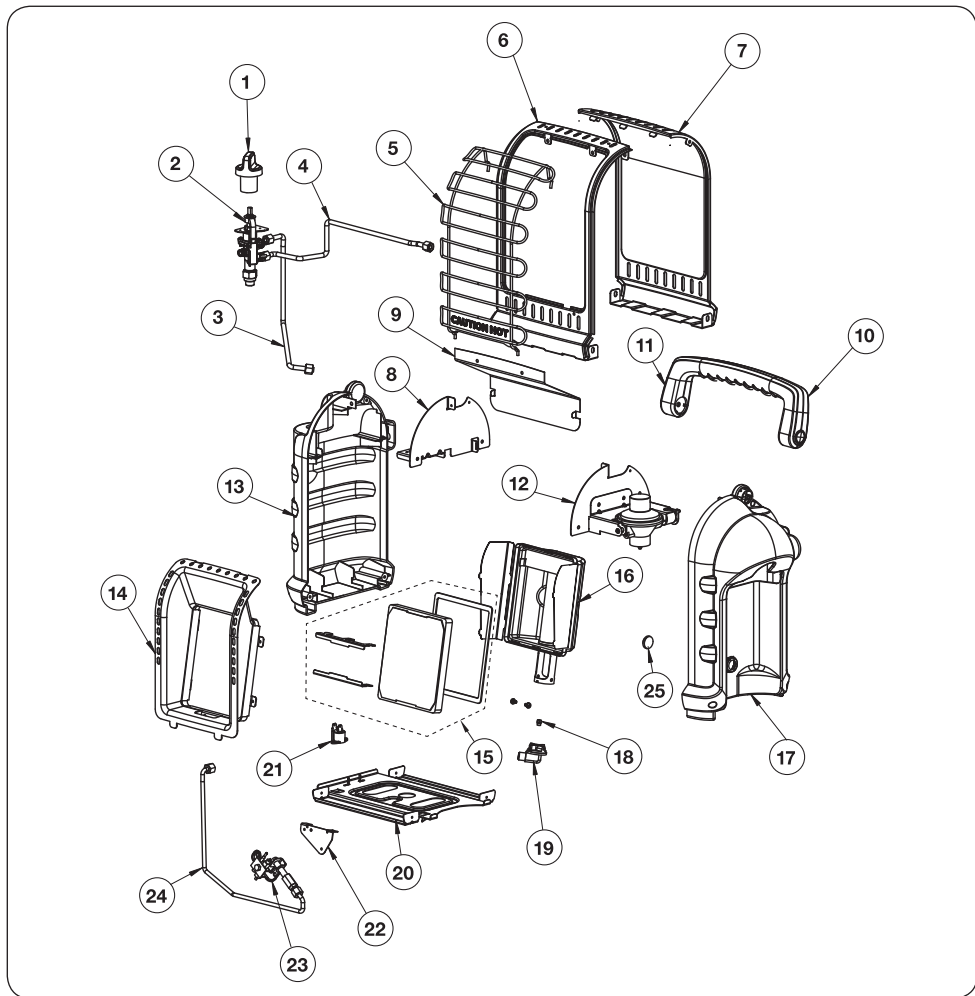

No	Part #	Description
1.	32017	Knob, Valve, Safety, Red
	32019	Knob, Valve, Safety, Green
2.	32054	Valve, Assy, Control
3.	32056	Tube, Burner, Main
4.	32053	Tube, Inlet, Assy
5.	32051	Guard, Wire
	32061	Guard, Wire, Heavy
6.	33092	Panel, Front, Metal, Red
	33094	Panel, Front, Metal, Yellow
	33093	Panel, Front, Metal, Green
7.	75191	Panel, Back, Metal, w/32004, Red
	75194	Panel, Back, Metal, w/32004, Yellow
	75196	Panel, Back, Metal, w/32004, Green

No	Part #	Description
8.	32027	Brkt, Valve
9.	32028	Heat, Shield
10.	32015	Handle, Back, Plastic, Gray
	32074	Handle, Back, Plastic, Black
11.	32014	Handle, Front, Plastic, Gray
	32072	Handle, Front, Plastic, Black
12.	75198	Assy, Regulator, w/Support
13.	32080	Housing, Left, Plastic, Gray
	32085	Housing, Left, Plastic, Black
14.	32021	Reflector, Metal
15.	33088	Tile, Replacement Kit, MH9BX
16.	32032	Burner, Assy
17.	33090	Housing, Right, Plastic, Gray
	33091	Housing, Right, Plastic, Black
18.	32068	Orifice, Assy with O-Ring

No	Part #	Description
19.	32052	Orifice, Holder
20.	32023	Floor, Panel, Metal
21.	73403	Switch, Tipover
22.	32046	Brkt, ODS (Oxygen Depletion Sensor)
23.	73404	ODS, Pilot, Assy
24.	32057	Tube, Pilot, Assy
25.	32067	Magnet, Tank



## Troubleshooting Instructions

Problem	Remedy
If Spark electrode does not produce spark.	Check spark electrode; if defective, replace ODS (Oxygen Depletion Sensor).
	Check igniter wire is correctly attached to spark electrode.
	Check igniter wire; if damaged, replace.
	Check piezo igniter; if defective, replace control valve.
If Spark electrode produces spark but pilot does not light.	No gas to heater – install disposable cartridge or connect hose and filter where required and turn on valve at remote cartridge.
	Check if “PILOT” position is properly aligned – turn gas control knob to “PILOT” position and depress.
	Check is pilot is blocked from spider web or dirt – clean pilot, see MAINTENANCE.
If Pilot flame does not stay lit when knob is released.	Check if control knob in “PILOT” position not completely depressed or held in long enough to purge air from lines.
	If pilot flame is not surrounding thermocouple – clean pilot, see MAINTENANCE.
	Check if pilot assembly is defective – replace.
	Check if tip switch wires are disconnected – connect.
If Main burner does not ignite.	Check if main burner orifice is blocked – clean burner, see MAINTENANCE.
If Heater keeps shutting “OFF” during normal operation.	Check if pilot is blocked – clean pilot, see MAINTENANCE.
	Tip over switch may have been activated from bumping heater. Re-light.
	Check if regulator is defective - Replace regulator.
	Check for internal contamination - Replace control valve and regulator.
	Call Technical Services for additional information.

## Specifications

<b>Part No:</b>	<b>MH9BX</b>
<b>Dimensions:</b>	<b>330 x 204 x 343mm</b>
<b>Net Weight:</b>	<b>3.602kg (excluding cartridge)</b>
<b>Injector Size:</b>	<b>0.93mm</b>
<b>Gas Consumption:</b>	<b>9.5 Mj/hr 189 g/hr</b>

### This Appliance

---

- Must only be serviced by an authorised person
- Suitable for camping use only
- Shall NOT be exposed to moisture or rain
- Shall only be used with a propane gas cylinder certified to:  
DOT2P, UN2037, EN417
- May be hazardous to attempt to fit other types of gas containers
- Only be used in a well ventilated area
- Can produce carbon monoxide which has no odor.  
Using it in an enclosed space (e.g. caravan, tents, marine craft, cars, mobile homes or similar locations) may cause death.



Gas Safety  
Certified

AS 2658:2008  
Cert. GSCS20193  
SAI Global



For Customer Service in New Zealand:  
**Aber Holdings Ltd**  
17 Mainstreet Place  
Te Rapa Hamilton  
New Zealand

For Customer Service in Australia:  
**Sitro Group Australia Pty Ltd**  
33-35 Lionel Road  
Mt Waverley VIC 3149  
Australia

Ph: 1300 174 876  
email: [sales@sitro.com.au](mailto:sales@sitro.com.au)